



HAL
open science

Convex Optimization for Energy Management of Parallel Hybrid Electric Vehicles

S Hadj-Said, Guillaume Colin, A Ketfi-Cherif, Yann Chamailard

► **To cite this version:**

S Hadj-Said, Guillaume Colin, A Ketfi-Cherif, Yann Chamailard. Convex Optimization for Energy Management of Parallel Hybrid Electric Vehicles. 8th IFAC International Symposium on Advances in Automotive Control (AAC2016), Jun 2016, Kolmarden, Sweden. pp.278-283. hal-01338034

HAL Id: hal-01338034

<https://univ-orleans.hal.science/hal-01338034>

Submitted on 27 Jun 2016

HAL is a multi-disciplinary open access archive for the deposit and dissemination of scientific research documents, whether they are published or not. The documents may come from teaching and research institutions in France or abroad, or from public or private research centers.

L'archive ouverte pluridisciplinaire **HAL**, est destinée au dépôt et à la diffusion de documents scientifiques de niveau recherche, publiés ou non, émanant des établissements d'enseignement et de recherche français ou étrangers, des laboratoires publics ou privés.

Convex Optimization for Energy Management of Parallel Hybrid Electric Vehicles

S. Hadj-Said ^{*,**} G. Colin ^{**} A. Ketfi-Cherif ^{*}
Y. Chamaillard ^{**}

^{*} Renault S.A.S, France (e-mail: souad.hadj-said@renault.com ; ahmed.ketfi-cherif@renault.com).

^{**} Univ. Orléans, PRISME, EA 4229, F45072, Orléans, France (e-mail: guillaume.colin@univ-orleans.fr ; yann.chamaillard@univ-orleans.fr)

Abstract: This paper presents a comparison between two optimization methods for the energy management of a parallel hybrid electric powertrain: convex programming and Pontryagin's Minimum Principle (PMP). The objective of this comparison is to validate the analytical solution by comparing the results with the ones obtained on the original model with Dynamic Programming (DP). Therefore, before its application, some necessary approximations and convexification were made on the original nonlinear and non-convex model. The validation of the simplified model was also carried out. In this paper, two cases are studied. In the first case, the supervisory control considers only the torque split between the Internal Combustion Engine (ICE) and the Electric Machine. In the second case, a binary decision ICE On/Off is included in the optimization problem. In order to solve the problem of the binary decision, which makes the problem non-convex, an analytical solution based on PMP is then proposed. The results show that the analytical solution is close to the optimal solution given by DP.

Keywords: Energy Management Strategy, Hybrid Electric Vehicles (HEV), Convex optimization, Pontryagin's Maximum Principle (PMP), Engine On/Off.

1. INTRODUCTION

The transport sector accounts for 26% of global energy consumption (Badin, 2013). This is the reason why, in recent years, extensive research has been undertaken in order to reduce energy consumption and pollution caused by transportation. In this paper, we focus on one of the solutions for achieving a near-term reduction of energy consumption proposed by the automotive industry, which is the use of Hybrid Electric Vehicles (HEVs). HEVs consist of at least two power sources, an internal combustion engine and one or more electric motors, as well as an energy buffer, typically a battery.

This means that an energy management solution must be found between power sources in the vehicle that minimizes fuel consumption. In simulation, optimal off-line approaches are interesting for design and component sizing purposes and real-time control strategy design. There are many approaches to design an optimal energy management strategy: deterministic Dynamic Programming (DP) (Pérez et al., 2006; Debert et al., 2010), stochastic DP (Johannesson et al., 2007), and Pontryagin's Maximum Principle (Serrao et al., 2009; Kim et al., 2011). While being a globally optimal energy management, dynamic programming is computationally expensive, which limits its application to low-order systems (typically two states). As far as PMP method is concerned, its inconvenient is the

sensitivity of the solution towards the boundary conditions (Serrao et al., 2011).

Recently, convex optimization (Boyd and Vandenberghe, 2004; Grant and Boyd, 2013) has attracted attention in the research field of energy management for HEVs. It is seen as an alternative method for the optimization of the power flows in HEVs due to its advantages, the most important of which is that it is computationally more efficient than DP or PMP. In Murgovski et al. (2013, 2012), convex optimization was employed to dimension the HEV powertrain especially the battery, whereas Hu et al. (2013) used it for energy efficiency analysis. In this study, we are interested in minimizing fuel consumption via convex optimization, with the use of an engine On/Off functionality to stop and start the engine during the driving cycle. This functionality enables a further fuel consumption reduction. Unfortunately, a binary variable for controlling the engine On/Off state cannot be included in a convex formulation as the set of integer numbers is not convex. To solve this kind of optimization problems, also known as a mixed integer problem, Murgovski et al. (2012) proposed that integer and binary variables should be decided a priori by heuristics. In Elbert et al. (2014), the optimal engine On/Off strategy is computed analytically using the PMP approach for a serial hybrid electric bus. In Nüesch et al. (2014), the engine On/Off and gearshift strategies are given by a combination of DP and PMP.

This paper is organized as follows. In section 2, the vehicle model is presented. In section 3, convex modeling and optimization are proposed for a first study case where the engine is running during the driving cycle which is presented so that the optimization problem considers only the torque split of a parallel electric hybrid powertrain. In section 4, a second case is studied where the engine On/Off decision is added to the optimization problem. Here, the PMP approach on the convex model is applied to find analytically the global optimal engine state and the optimal torque split. Then, the optimal torque split is also determined by a convex solver. In section 5, simulation results obtained in the two study cases are compared to the results obtained by DP. The purpose of this comparison is to establish the performances of the simplified model and the analytical solution for real-time energy management strategies.

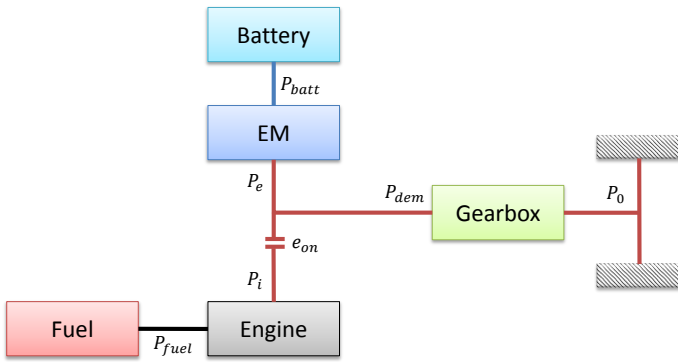

Fig. 1. Parallel HEV powertrain model with engine On/Off clutch

2. VEHICLE MODEL

In this section, the HEV model, often presented as quasi-static, is given. Fig. 1 illustrates the configuration of the powertrain architecture considered, which consists of a battery, an electric motor, an internal combustion engine delivering power to the wheels via a transmission block and a clutch e_{on} , which couples or decouples the engine with the rest of the powertrain. The vehicle dynamics is governed by the following equations:

$$F_{wheel}(t) = m_{vec}\dot{v}(t) + F_{res}(t)[N] \quad (1)$$

$$T_0(t) = F_{wheel}(t) \cdot R_{wheel}[Nm] \quad (2)$$

$$\omega_0(t) = v(t)/R_{wheel}[rad/s] \quad (3)$$

where F_{wheel} is the force at the wheels, $F_{res}(t) = F_{tires} + F_{aero}(t)$ the resistive force which includes the aerodynamic force ($F_{aero}(t) = 0.5 \cdot \rho \cdot S_{cx} \cdot v^2(t)$) and the tire resistance (F_{tires}) (here assumed constant), $m_{vec}[kg]$ the total vehicle mass and $R_{wheel}[m]$ the wheel radius.

2.1 Transmission

Transmission between the wheels and the crankshaft is given by the following static model:

$$\omega_{dem}(t) = \omega_0(t)r_{Gear} \quad (4)$$

$$T_{dem}(t) = \begin{cases} T_0(t)/(\eta_{Gear}r_{Gear}) & \text{if } T_0(t) \geq 0 \\ (T_0(t)\eta_{Gear})/r_{Gear} & \text{if } T_0(t) \leq 0 \end{cases} \quad (5)$$

$$P_{dem}(t) = T_{dem}(t)\omega_{dem}(t) = T_e(t)\omega_e(t) + e_{on}(t)T_i(t)\omega_i(t) \quad (6)$$

where T_0 , ω_0 , T_{dem} , ω_{dem} , T_e , ω_e , T_i , ω_i are torque and speed of respectively the wheel, the crankshaft, the electric motor and the internal combustion engine. e_{on} stands for the binary engine On/Off control, $e_{on}(t) = \{0, 1\}$ where $e_{on} = 1$ means that the engine is activated.

2.2 Battery

The battery is modeled as a simple resistive circuit (Badin, 2013; Murgovski et al., 2012) and the battery power is given by:

$$P_{batt}(t) = OCV(SoE)i_{batt}(t) - R_{batt}(SoE)i_{batt}^2(t)[w] \quad (7)$$

$$P_{batt}(t) = P_e(t) + P_{aux} \quad (8)$$

The State of Energy (SoE) of the battery is defined as:

$$S\dot{o}E(t) = -\frac{OCV(SoE)i_{batt}(t)}{E_{max}} \quad (9)$$

where $E_{max}[J]$ is the maximal battery energy. The current $i_{batt}[A]$ and SoE are limited by:

$$i_{batt_{min}} \leq i_{batt}(t) \leq i_{batt_{max}} \quad (10)$$

$$SoE_{min} \leq SoE(t) \leq SoE_{max}. \quad (11)$$

2.3 Engine

The engine model consists of the fuel power consumed by the engine to deliver mechanical power:

$$P_{fuel}(t) = e_{on}(t)H_f m_f(T_i(t), \omega_i(t)) \quad (12)$$

where $m_f(T_i(t), \omega_i(t))[g/s]$ is the fuel consumption map of the engine and $H_f[J/g]$ the fuel lower heating value.

The engine torque T_i is limited by a function of the engine speed ω_i :

$$T_{i_{min}}(\omega_i(t)) \leq T_i(t) \leq T_{i_{max}}(\omega_i(t)) \quad (13)$$

If the gear ratio is given, the engine speed is directly obtained from ω_{dem} and it is not decided by the optimization.

$$\omega_i(t) = \omega_{dem}(t) \quad (14)$$

2.4 Electric Motor (EM)

The electric motor model expresses the electric power produced by EM which includes the mechanical power delivered and the losses obtained from the specific power loss of the EM $loss(T_e(t), \omega_e(t))$. So, the electric power (P_e) produced by the EM has the following expression:

$$P_e(t) = T_e(t)\omega_e(t) + loss(T_e(t), \omega_e(t)) \quad (15)$$

Here also, the EM speed is obtained from ω_{dem} .

$$\omega_e(t) = \omega_{dem}(t) \quad (16)$$

The EM torque is limited by torque limits depending on the EM speed:

$$T_{e_{min}}(\omega_e(t)) \leq T_e(t) \leq T_{e_{max}}(\omega_e(t)) \quad (17)$$

3. CONVEX OPTIMIZATION WITHOUT ENGINE ON/OFF STRATEGY

As can be seen from Elbert et al. (2014); Nüesch et al. (2014); Yuan et al. (2013), there are many approaches to

the energy management problem in HEVs. These different methods focus on the same objective and try to solve a common problem, i.e. a problem of optimization under constraints. In this section, the application of convex optimization to the HEV energy management problem is presented. In the following, $e_{on} = 1$. P_c is the continuous optimization problem given by:

$$P_c : \begin{cases} \min_{u \in U} J(x(t), u(t)) \\ \dot{x} = f(x(t), u(t)) \\ C_e(x(t), u(t)) = 0 \\ C_i(x(t), u(t)) \leq 0 \end{cases} \quad (18)$$

where the state is $x = SoE$, the control input is $u = T_e$, C_e are the equality constraints and C_i are the inequality constraints. The goal of this paper is to minimize fuel consumption under constraints. Therefore, the objective function J_c has to be reformulated as follows:

$$J(x(t), u(t)) = \int_{t_0}^{t_f} P_{fuel}(t) e_{on}(t) dt \quad (19)$$

In the following, the time-discretized optimization problem is solved by a convex solver. For a chosen sampling time Δt , and by applying the Euler formula, the optimization problem is rewritten as follows:

$$P_d : \begin{cases} \min_{u \in U} J_d(x(k), u(k)) \\ x(k+1) = \Delta t \cdot f(x(k), u(k)) + x(k) \\ C_e(x(k), u(k)) = 0 \\ C_i(x(k), u(k)) \leq 0 \end{cases} \quad (20)$$

and:

$$J_d(x(k), u(k)) = \sum_{k=0}^N P_{fuel}(k) e_{on}(k) \quad (21)$$

Compared to a general constrained optimization problem, the convex optimization problem has three requirements:

- the cost function (21) must be convex;
- the inequality constraint functions $C_i(x(k), u(k))$ must be convex;
- the equality constraint functions $C_e(x(k), u(k))$ must be affine.

Section 3.1 describes the necessary approximations for a reformulation of the original problem into a convex optimization problem.

3.1 Convex modeling

In order to apply convex programming, the nonlinear vehicle model has to be approximated by a convex model, see Boyd and Vendenbergh (2004).

Battery model To preserve the problem convexity, the following two assumptions are made (Badin, 2013; Murgovski et al., 2012). Firstly, the open circuit voltage (OCV) and the resistance on the battery R_{batt} are considered constant. This should be checked after optimization. Secondly, equation (7) is relaxed with inequality.

$$OCV(SoE) = \overline{OCV} \quad (22)$$

$$R_{batt}(SoE) = \overline{R_{batt}} \quad (23)$$

$$P_{batt}(t) \leq \overline{OCV} i_{batt}(t) - \overline{R_{batt}} i_{batt}^2(t) \quad (24)$$

Engine model Here, equation (12) is approximated by a second order polynomial with speed dependent coefficients.

$$\hat{P}_{fuel}(t) = a_0(\omega_i(t)) + a_1(\omega_i(t))T_i(t) + a_2(\omega_i(t))T_i^2(t) \quad (25)$$

where the coefficients a_0 , a_1 and a_2 are found by least squares for a number of grid points of ω_i .

Fig. 2 is the representation of an example of the original and the approximated engine models. The maximum relative error (RE_{fuel}) of the fuel power approximation was calculated using the expression $RE_{fuel}(t) = \max_{\omega_i} \left(\frac{P_{fuel}(\omega_i(t)) - \hat{P}_{fuel}(\omega_i(t))}{P_{fuel}(\omega_i(t))} \right)$. Fig.2 shows that the approximated engine model is sufficiently representative of the original engine model.

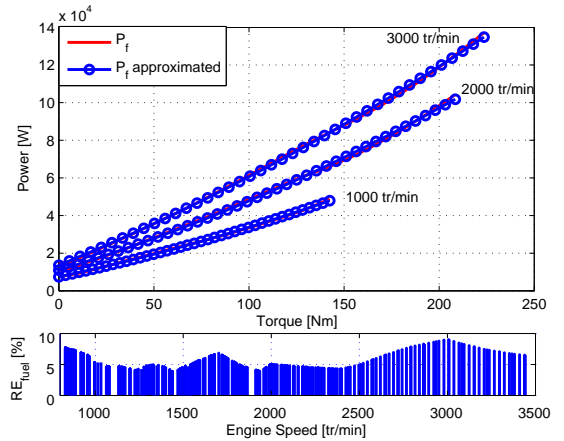

Fig. 2. The original and the approximated fuel power model for representative engine speeds (top) and the maximum relative error resulting from this approximation (bottom) for NEDC cycle speeds

Electric Motor model Here, equation (15) is relaxed with inequality and approximated by a second order polynomial with speed dependent coefficients.

$$P_e(t) \geq b_0(\omega_e(t)) + b_1(\omega_e(t))T_e(t) + b_2(\omega_e(t))T_e^2(t) = \hat{P}_e(t) \quad (26)$$

where the coefficients b_0 , b_1 and b_2 are found by least squares for a number of grid points of ω_e . Fig. 3 is the representation of an example of the original and the approximated EM models. The relative error (RE_e) of the electrical power approximation was calculated using the expression $RE_e(t) = \max_{\omega_e} \left(\frac{P_e(\omega_e(t)) - \hat{P}_e(\omega_e(t))}{P_e(\omega_e(t))} \right)$. Fig. 3 shows that the approximated EM model is sufficiently representative of the original EM model. As for RE_{fuel} , RE_e is due to the interpolation between two speeds (e.g between 2500 rpm and 3000 rpm).

3.2 Convex problem resolution

The original problem, after approximations, is rewritten as a convex problem and can be solved by a convex solver. Moreover, according to the PMP, minimizing (19) is equivalent to minimizing the Hamiltonian function which is calculated from (9) and (12), as follows:

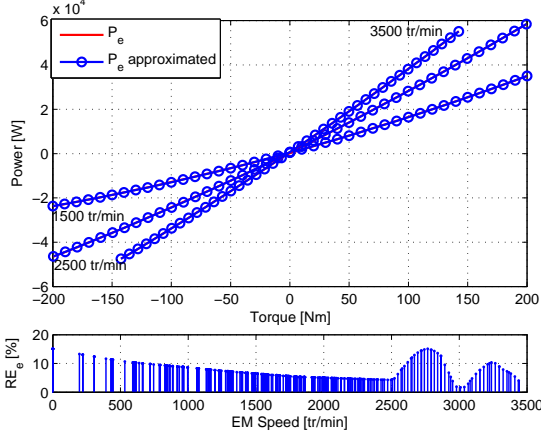

Fig. 3. The original and the approximated electric power model for representative EM speeds (top) and the maximum relative error resulting from this approximation (bottom) for NEDC cycle speeds

$$H(x(t), u(t)) = P_f(T_e(t), t)e_{on}(t) + s(t) \frac{\overline{OCV}i_{batt}(T_e(t), t)}{E_{max}} \quad (27)$$

Where $x(t) = SoE(t)$, $u(t) = [T_e(t) \ e_{on}(t)]^T$, s is the Lagrange multiplier and $\overline{OCV}i_{batt}(t) = P_{batt}(t) + \overline{R}_{batt}i_{batt}^2(t)$. Here, it is assumed that the battery losses are neglected ($\overline{R}_{batt}i_{batt}^2(t) \approx 0$), therefore, $\overline{OCV}i_{batt}(t) \approx P_{batt}(t)$. Thus, by replacing $P_{batt}(t)$ by (8), $P_f(t)$ by (25) and $P_e(t)$ in (8) by (26), the Hamiltonian (27) becomes: $H(t, u(t)) = a_0(t) + a_1(t)T_i(t) + a_2(t)T_i^2(t) + s(t)(b_0(t) + b_1(t)T_e(t) + b_2(t)T_e^2(t) + P_{aux}(t))$. Therefore, H is minimum when $\frac{\partial H}{\partial T_e} = 0$, so that:

$$T_e^*(t) = \frac{2a_2(t)T_{dem}(t) + a_1(t) - s^*(t)b_1(t)}{2(a_2(t) + s^*(t)b_2(t))} \quad (28)$$

Finally, in order to calculate the optimal torque split, the optimal equivalence factor s^* must be found so that the desired final state is reached. Here, s^* is determined by dichotomy.

Afterwards, a convex solver is used to solve the convex problem and its results are compared to the results of PMP. The optimization problem is presented to the solver as follows

$$\begin{cases} \min \sum_{k=1}^N \hat{P}_{fuel}(k)e_{on}(k) \\ s.t. \ T_{dem}(k) = T_e(k) + e_{on}(k)T_i(k) \\ P_e(k) \geq b_0(\omega_e(k)) + b_1(\omega_e(k))T_e(k) + b_2(\omega_e(k))T_e^2(k) \\ P_{batt}(k) \leq \overline{OCV}i_{batt}(k) - \overline{R}_{batt}i_{batt}^2(k) \\ T_{e_{min}}(\omega_e(k)) \leq T_e(k) \leq T_{e_{max}}(\omega_e(k)) \\ T_{i_{min}}(\omega_i(t)) \leq T_i(k) \leq T_{i_{max}}(\omega_i(t)) \\ SoE_{min} \leq SoE(k) \leq SoE_{max} \\ i_{batt_{min}} \leq i_{batt}(k) \leq i_{batt_{max}} \\ P_{batt}(k) = P_e(k) + P_{aux} \\ SoE(k+1) = SoE(k) - \Delta t \overline{OCV}i_{batt}(k)/E_{max} \\ SoE(1) = SoE(N) = 50\% \end{cases} \quad (29)$$

Then, (29) is rewritten in a matrix form. The quadratic functions are expressed in the following form: $X^TAX + cX + d$, whereas the affine functions are formulated as: $eX + l$.

$X(4N \times 1)$ is the optimization variable, such that:

$$X = \begin{bmatrix} T_i \\ T_e \\ SoE \\ i_{batt} \end{bmatrix}$$

$$\begin{aligned} T_i &= [T_i(1)T_i(2)\dots T_i(N)]^T (N \times 1) \\ T_e &= [T_e(1)T_e(2)\dots T_e(N)]^T (N \times 1) \\ SoE &= [SoE(1)SoE(2)\dots SoE(N)]^T (N \times 1) \\ i_{batt} &= [i_{batt}(1)i_{batt}(2)\dots i_{batt}(N)]^T (N \times 1) \end{aligned}$$

Finally, the convex problem (29) can be solved using the solvers available in Grant and Boyd (2013), such as SeDuMi (Labit et al., 2002), or SDPT3 (Toh et al., 2006).

4. OPTIMIZATION WITH ENGINE ON/OFF STRATEGY

In this section, the engine On/Off functionality is considered in the optimization problem (P) ($e_{on} = \{0, 1\}$). As given in section 2, the binary variable e_{on} is present in (6) and (12). Since e_{on} makes the problem (P) nonconvex, it cannot be included as a decision variable for the solver. Therefore, this decision must precede the resolution of the convex problem by the solver. In the following, the PMP is used to find the globally optimal engine state and the optimal torque split. Then, the optimal engine On/Off decision is introduced a priori to the solver which calculates the globally optimal torque split.

The Hamiltonian (27) can be analyzed for two cases: engine On H_{On} and engine Off H_{Off} , where:

$$H = \begin{cases} H_{On}, & \text{for } e_{on} = 1 \\ H_{Off}, & \text{for } e_{on} = 0 \end{cases}$$

with

$$\begin{aligned} H_{On} &= a_0(t) + a_1(t)T_i(t) + a_2(t)T_i^2(t) \\ &\quad + s(t)(b_0(t) + b_1(t)T_e(t) + b_2(t)T_e^2(t) + P_{aux}(t)) \\ H_{Off} &= s(t)(b_0(t) + b_1(t)T_e(t) + b_2(t)T_e^2(t) + P_{aux}(t)) \end{aligned}$$

In the case "On", H_{On} is minimum for (28), whereas in the case "Off", $e_{on} = 0$, H_{Off} is minimum when

$$T_e^{*,Off}(t) = T_{dem}(t) \quad (30)$$

since $T_i(t) = 0$ and (6) have to be satisfied. The condition of optimality, minimizing the Hamiltonian, to switch on the engine is:

$$H_{On}(T_e^{*,On}) \leq H_{Off}(T_e^{*,Off}) \quad (31)$$

By inserting (28) and (30) in (31), the conditions on the requested torque become:

$$T_{dem}(t) \leq T_{lim}^1(t) \quad (32)$$

$$T_{dem}(t) \geq T_{lim}^2(t) \quad (33)$$

Where $T_{lim}^{1,2}(t) = \frac{a_1(t) - s^*(t)b_1(t) \mp \sqrt{a_0(t)(a_2(t) + s^*(t)b_2(t))}}{2s^*(t)b_2(t)}$.

From (32) and (33), the torque threshold is a function of the optimal equivalence factor and the model parameters ($a_0(t), a_1(t), a_2(t)$ and $b_0(t), b_1(t), b_2(t)$). The optimal engine On/Off decision is given by

$$e_{on}^*(t) = \begin{cases} 1, & \text{if } T_{dem}(t) \leq T_{lim}^1(t) \text{ or } T_{dem}(t) \geq T_{lim}^2(t) \\ 0, & \text{else} \end{cases}$$

Fig. 4 shows the optimization On/Off process. Firstly, the optimal engine state e_{on}^* and the optimal EM torque T_{ePMP}^* are calculated by finding a first s^* by dichotomy. As the control could be singular (Delprat and Hofman, 2014), a second parameter t_s was introduced to switch for another value of s^* in order to converge to the desired final SoE. t_s permits to switch between two values of s^* (e.g. s_1^* and s_2^* in Fig. 5). The existence of t_s is demonstrated by the fact that (34) is continuous, $SoE_{t_f}(t_s = t_0) > 50\%$ and $SoE_{t_f}(t_s = t_f) < 50\%$. The expression of $SoE_{t_f}(t_s)$ is given by:

$$SoE_{t_f}(t_s) = - \int_{t_0}^{t_s} \dot{SoE}(t) dt|_{s=s_1^*} - \int_{t_s}^{t_f} \dot{SoE}(t) dt|_{s=s_2^*} \quad (34)$$

Secondly, the optimal EM torque T_{eCVX}^* is also found by a convex solver for the predefined command e_{on} . To ensure optimality in the solution given by convex programming, the equivalence factor s_{out} must be optimal. In Murgovski et al. (2013), it was shown that the necessary condition for a globally optimal solution is: $s_{in} \equiv s_{out}$.

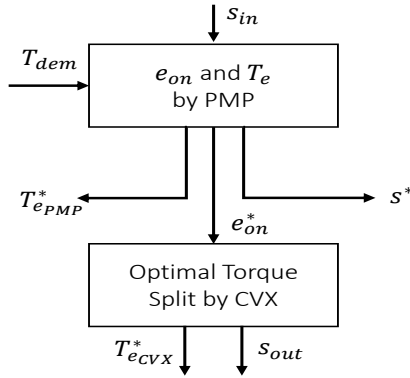

Fig. 4. Optimization process including engine On/Off strategy

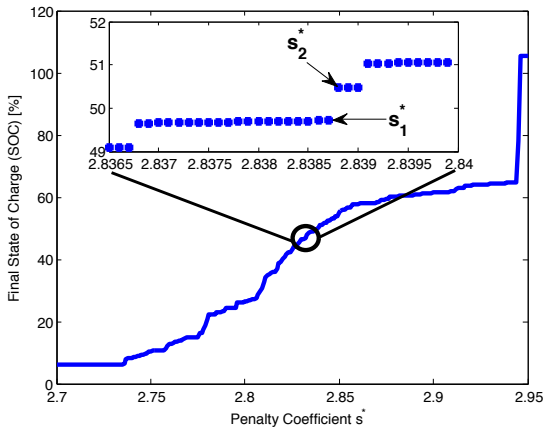

Fig. 5. Discontinuities in the dependence of the final SoE of a constant equivalence factor s^*

5. RESULTS

In this section, the evaluation of the convex method is presented by comparing its results to DP results. In order to ensure the robustness of the control (torque split and/or engine state) obtained from the simplified model, the latter

was applied on the original model. For each method, it is assumed that the driving cycle is given. The minimum, maximum and initial value of the SoE is 25%, 85% and 50%, respectively.

Tables 1 and 2 summarize the results obtained in terms of fuel consumption (FC) and computation time for four cycles: NEDC, ARTEMIS urban, road and highway. For the convex method, the fuel consumption value was obtained by applying the strategy on the original vehicle model.

Cycle	Strategy	CPU time [s]	FC [L/100km]
NEDC	CVX	6	4.69
	DP	18	4.69
	PMP _{CO}	4	4.69
ARTEMIS road	CVX	7	6.75
	DP	17	6.75
	PMP _{CO}	6	6.75
ARTEMIS highway	CVX	5	10.16
	DP	17	10.16
	PMP _{CO}	6	10.16

Table 1. Fuel consumption and time computation results without engine On/Off strategy

Cycle	Strategy	CPU time [s]	FC [L/100km]
NEDC	PMP/ CVX	13	2.39
	DP	28	2.38
	PMP _{CO}	10	2.39
ARTEMIS road	PMP/ CVX	13	3.84
	DP	26	3.83
	PMP _{CO}	8	3.84
ARTEMIS highway	PMP/ CVX	12	6.38
	DP	27	6.34
	PMP _{CO}	7	6.38

Table 2. Fuel consumption and time computation results with engine On/Off strategy

From tables 1 and 2, convex optimization finds almost the same fuel consumption as the one found by DP. These results prove that the solution based on the simplified model is very close to the globally optimal solution. In addition, the CPU time of the analytical method is lower than the one of DP and almost the same as convex programming. Fig. 6 and Fig. 7 show that the strategies provide a similar SoE trajectory.

6. CONCLUSION

In this paper, convex optimization is presented and applied to calculate the energy management strategy for a parallel HEV. The results of the comparison show that the convex method, which is based on simplified models, provides an optimal solution close to the global optimum given by DP. This leads to the validation of the approximated models and encourages their use for embedded optimal control. Moreover, the convex strategy presents two other attractive advantages. The first one is its low computation time compared to DP which will be even more interesting when the optimization problem has more than one state variable. The second one is that it does not require discretization of the continuous control and state variables which introduces errors in the solutions. In addition, the PMP analytical method has two more important

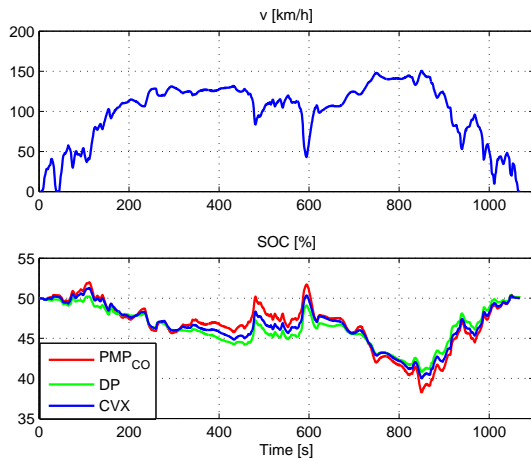

Fig. 6. Comparison of the SoE trajectory obtained by DP and convex optimization for ARTEMIS highway cycle without engine On/Off strategy

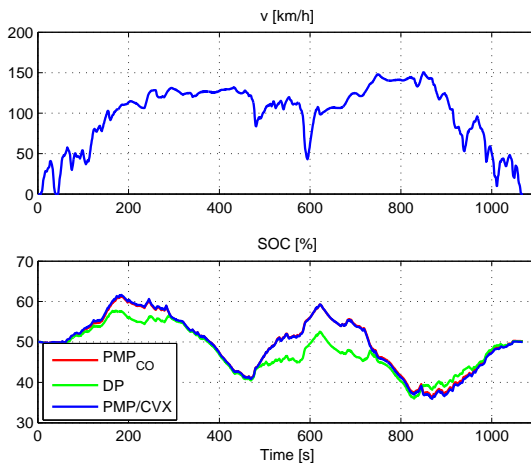

Fig. 7. Comparison of the SoE trajectory obtained by DP and convex optimization for ARTEMIS highway cycle with engine On/Off strategy

advantages: it is easier to implement and to evaluate its robustness.

From the results of optimization with the engine On/Off strategy presented in section 5, two important conclusions can be drawn: first, the engine On/Off functionality allows a significant reduction in fuel consumption. Secondly, the analytical method is very efficient, since its solution is very close to the globally optimal solution given by DP.

REFERENCES

Badin, F. (2013). *Hybrid Vehicles*. Technip.
 Boyd, S. and Vandenberghe, L. (2004). *Convex Optimization*. Cambridge University Press.
 Debert, M., Colin, G., Chamaillard, Y., Mensler, M., Ketfcherif, A., and Guzzella, L. (2010). Energy management of a high efficiency hybrid electric automatic transmission. Technical report, SAE Technical Paper.
 Delprat, S. and Hofman, T. (2014). Hybrid vehicle optimal control: Linear interpolation and singular control. In *Vehicle Power and Propulsion Conference (VPPC), 2014 IEEE*, 1–6.

Elbert, P., Nuesch, T., Ritter, A., Murgovski, N., and Guzzella, L. (2014). Engine on/off control for the energy management of a serial hybrid electric bus via convex optimization. *Vehicular Technology, IEEE Transactions on*, 63(8), 3549–3559.
 Grant, M. and Boyd, S. (2013). Cvx: Matlab software for disciplined convex programming (web page and software).
 Hu, X., Murgovski, N., Johannesson, L., and Egardt, B. (2013). Energy efficiency analysis of a series plug-in hybrid electric bus with different energy management strategies and battery sizes. *Applied Energy*, 111, 1001–1009.
 Johannesson, L., Asbogard, M., and Egardt, B. (2007). Assessing the potential of predictive control for hybrid vehicle powertrains using stochastic dynamic programming. *IEEE Transactions*.
 Kim, N., Cha, S., and Peng, H. (2011). Optimal control of hybrid electric vehicles based on pontryagin’s minimum principle. *Control Systems Technology, IEEE Transactions on*, 19(5), 1279–1287.
 Labit, Y., Peaucelle, D., and Henrion, D. (2002). Sedumi interface 1.02: a tool for solving lmi problems with sedumi. In *Computer Aided Control System Design, 2002. Proceedings. 2002 IEEE International Symposium on*, 272–277. IEEE.
 Murgovski, N., Johannesson, L., Sjöberg, J., and Egardt, B. (2012). Component sizing of a plug-in hybrid electric powertrain via convex optimization. *Mechatronics*, 22(1), 106–120.
 Murgovski, N., Johannesson, L.M., and Sjöberg, J. (2013). Engine on/off control for dimensioning hybrid electric powertrains via convex optimization. *Vehicular Technology, IEEE Transactions on*, 62(7), 2949–2962.
 Nuesch, T., Elbert, P., Flankl, M., Onder, C., and Guzzella, L. (2014). Convex optimization for the energy management of hybrid electric vehicles considering engine start and gearshift costs. *Energies*, 7(2), 834–856.
 Pérez, L.V., Bossio, G.R., Moitre, D., and García, G.O. (2006). Optimization of power management in an hybrid electric vehicle using dynamic programming. *Mathematics and Computers in Simulation*, 73(1), 244–254.
 Serrao, L., Onori, S., and Rizzoni, G. (2009). Ecms as a realization of pontryagin’s minimum principle for hev control. In *Proceedings of the American control conference*, 3964–3969.
 Serrao, L., Onori, S., and Rizzoni, G. (2011). A comparative analysis of energy management strategies for hybrid electric vehicles. *Journal of Dynamic Systems, Measurement, and Control*, 133(3), 031012.
 Toh, K., Tütüncü, R., and Todd, M. (2006). On the implementation and usage of sdpt3—a matlab software package for semidefinite-quadratic-linear programming, version 4.0.
 Yuan, Z., Teng, L., Fengchun, S., and Peng, H. (2013). Comparative study of dynamic programming and pontryagin’s minimum principle on energy management for a parallel hybrid electric vehicle. *Energies*, 6(4), 2305–2318.